

# Installation Instructions

# SPACEDEC DONUT POLE

## Single / Double / Triple

### Important Notes

- Each Donut Clamp Assembly supports a maximum weight of 11.5kg (25lbs)
  - Donut Pole Single supports a total of: 11.5kg (25lbs)
  - Donut Pole Double supports a total of: 23kg (51lbs)
  - Donut Pole Triple supports a total of: 34.5kg (76lbs)
- This product suits VESA compliant displays with 75mm x 75mm (3" x 3") and 100mm x 100mm (4" x 4") mounting hole patterns.
- The manufacturer does not accept responsibility for incorrect installation

### Component Checklist

Check you have received all parts against this component checklist according to the product you have purchased.

#### Donut Pole Single

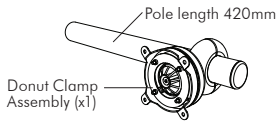

#### Bits Box

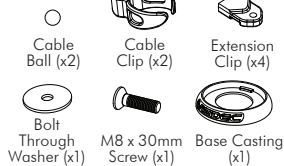

#### Mounting Screws



#### Donut Pole Double

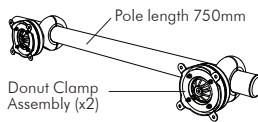

#### Bits Box

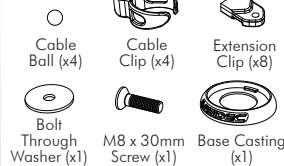

#### Mounting Screws



#### Donut Pole Triple

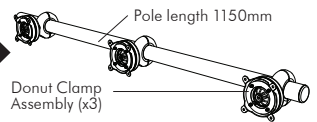

#### Bits Box

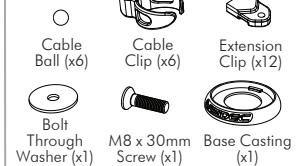

#### Mounting Screws



#### Desk Clamp Box Note: Only one Desk Clamp Box is included in every Donut Pole purchased.

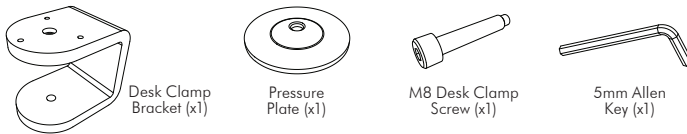

#### TOOLS REQUIRED:

- Power Drill
- 10mm (3/8") or 6mm (1/4") Drill Bit
- Phillips Head Screw Driver

### A Mounting Options

There are two Mounting Options: **Bolt Through** and **Desk Clamp**

To use the **Bolt Through** system, (Suits desktop thicknesses of 12mm-40mm [1/2"-1 1/2"]) follow the Bolt Through instructions at **A.1.**

To use the **Desk Clamp**, (Suits desktop thicknesses of 12mm-38mm [1/2"-1 1/2"]) follow the Desk Clamp instructions at **A.2.** overleaf.

#### A.1. Bolt Through

Drill a 9mm (3/8") hole in the work surface at the desired position and assemble as shown.

**NOTE:** It is recommended that the pole assembly be mounted towards the rear edge of the work surface.

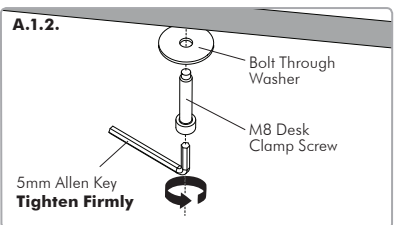
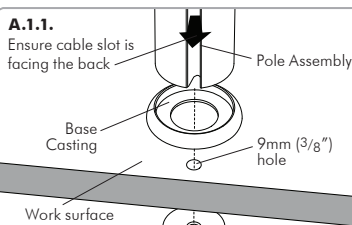

## A.2. Desk Clamp

### A.2.1.

Attach the Desk Clamp Bracket to the bottom of the Pole Assembly using the M8 x 30mm Screw.

**Tighten Firmly** using the 5mm Allen Key. Ensure the Visdec Logo on the Base Casting is facing the front as shown.

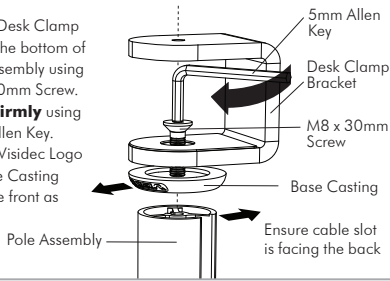

### A.2.2.

Attach the Donut Pole Assembly using the Desk Clamp as shown.

**Note:** Desk Clamp suits 12mm (1/2") - 38mm (1 1/2") thick work surfaces. Adjust the height of the Pressure Plate to suit your work surface.

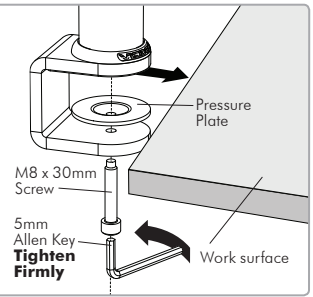

## B Adjust the height of pre-assembled Donut Clamps

### B.1.

Loosen both Donut bolts using the supplied 5mm Allen Key.

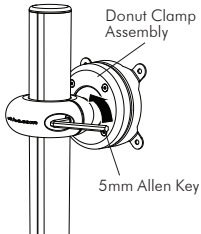

### B.2.

Adjust the Donut Clamp Assembly to desired position.

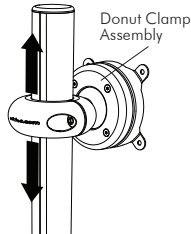

### B.3.

Tighten both Donut bolts firmly.

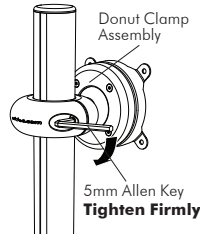

### IMPORTANT:

When tightening the Donut Clamp, each of the Donut bolts must be tightened evenly, as failure to do so will damage the Donut Clamp. Do not over-tighten as this may also result in damage.

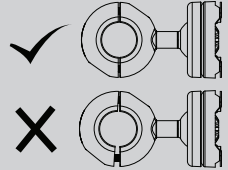

## C Mount Displays

Choose the correct Mounting Screws supplied in the bits box and attach the display as shown.

**Note:** Extension Clips are included to suit VESA 100mm x 100mm (4" x 4") Mounting Hole Patterns.

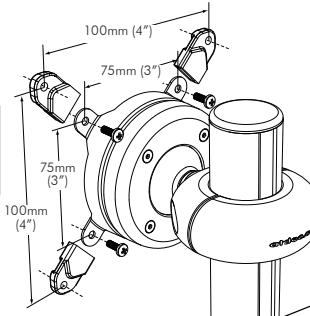

## E Cable Management

Use either Cable Balls or Clips to secure the cables from your displays to the pole as shown.

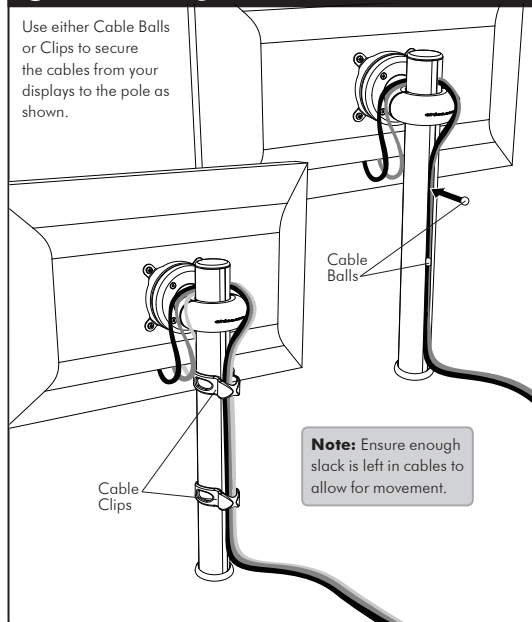

**Note:** Ensure enough slack is left in cables to allow for movement.

## D Adjust Ball Joint Mechanism

Adjust the Ball Joint Mechanism to suit the weight of your display. Tighten or loosen screws evenly with the supplied 2.5mm Allen Key, 1/4 turn at a time.

**TIGHTEN**

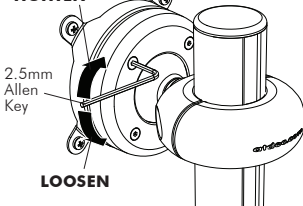

**LOOSEN**

**atdec**

the visdec display mounting company